

REV.	Description	Date
1	spec. revise	2012/5/28
2	upgrade drawing	2014/2/27

Specification

General Characteristics

Locking system: Screw
 Termination: Screw
 Shell protection: IP67
 Wire gauge: 20-14

Electrical Characteristics

Rated Current: 16A
 Contact Resistance: <10mΩ
 Insulation Resistance: >10MΩ

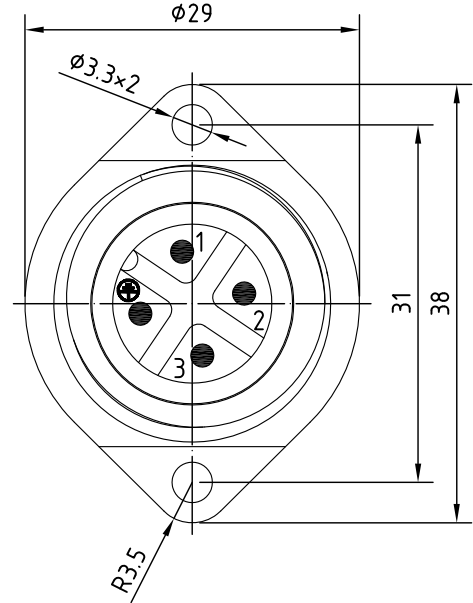
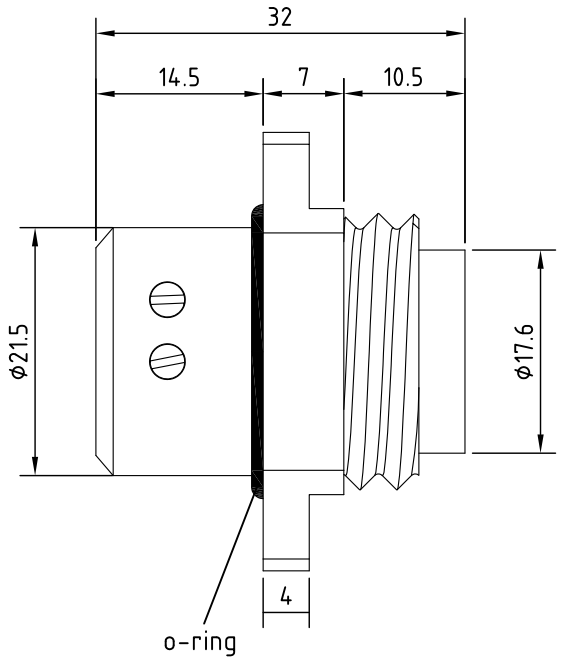

RoHS

3	terminal	gold plated brass	4
2	o-ring	Rubber	1
1	body	PA (UL 94V-0)	1
Item	Description	Material	Q'TY



Unicable Co., Ltd. 國陽電業有限公司

5F., No. 111-33, Sec. 4, San Ho Road, San Chung City, Taiwan, R.O.C.
<http://www.unicable.com.tw> TEL:+886-2-2286-2122 FAX:+886-2-2286-1010

DATE	2016/10/7	PART NO.	UT-3399-P-04
DWN	GINA	REV.	2
CHK			
UNIT	MM		

ITEM	In-Field Installable Circular Connector
------	---